

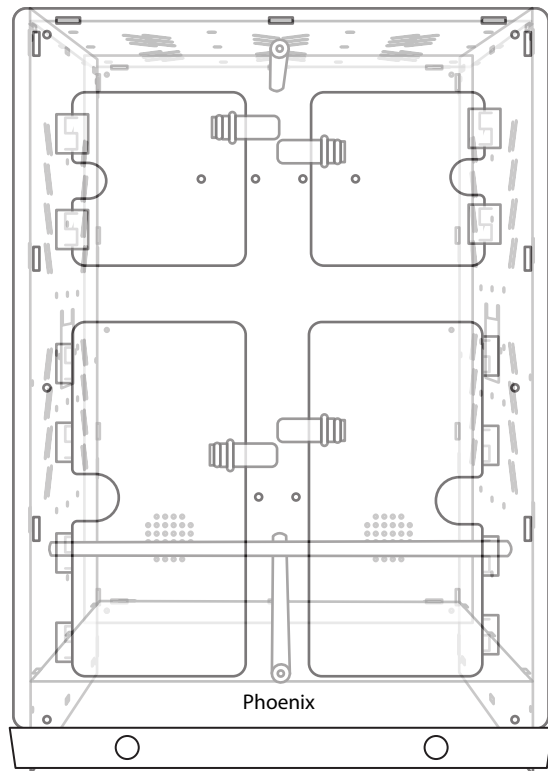

ACRYLICAGE

LARGE



ASSEMBLY INSTRUCTIONS

Getting started! Read these notes first:

1. Review these instructions thoroughly before attempting to assemble the cage. If you still require assistance, please contact **Acrylic Habitats Customer Service**.
 - a. Phone: **(984) 777-4811**
 - b. Email: **customerservice@acrylichabitats.com**
 - c. Online: **www.acrylichabitats.com**
2. **Review All Parts:** If parts have been damaged or are missing, please contact Acrylic Habitats Customer Service.
3. **Tools:** Phillips Screw Driver (not included). If using power tools, please be careful not to overtighten any screws.
4. Two-person assembly is recommended for best results.
5. **Protective Paper:** Please note the orientation stickers on the protective paper. Test fit all pieces before removing the paper. If any of the protective paper sticks to the acrylic, we recommend using Goo Gone or an ammonia free glass cleaner to remove excess glue.
6. **Return Policy:** Returns are **ONLY** accepted in the original packaging with the protective paper still intact.
7. Visit **www.acrylichabitats.com** for tutorials and assembly videos!
8. Please do not leave the cage outside in direct sunlight. Acrylic is an insulative material and may overheat.



Parts List

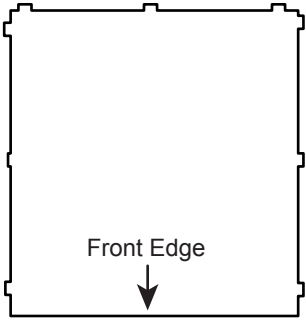

Bottom

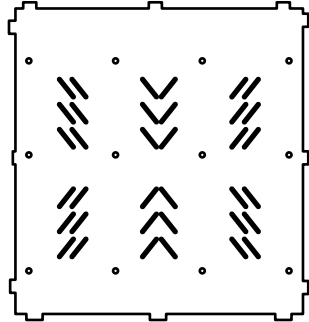

Top

(please note, one side has a large gap to add strip lights. The gap can either go in the back or the front of the cage)

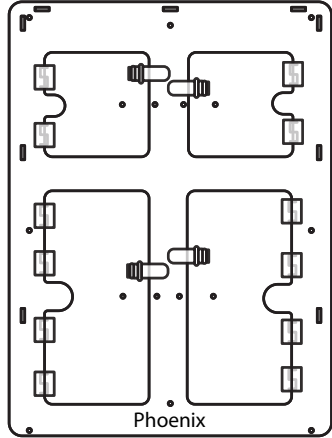

Front

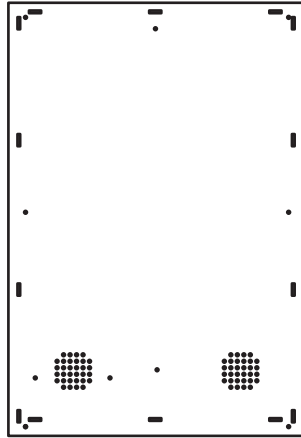

Back

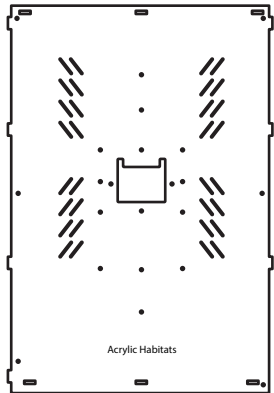

Left Side

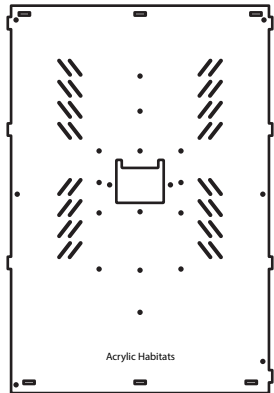

Right Side

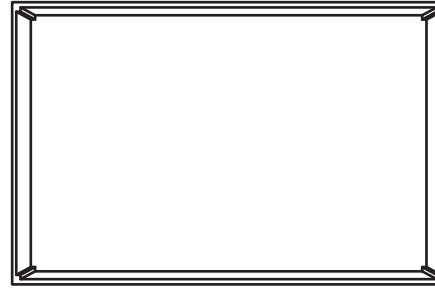

Tray Body



Tray Face Plate



Hex Nut Driver



1/4" Acrylic Drill Bit



Side Face Plate (2)



Door Knobs with screws (6)



Door Jam with screws (2)

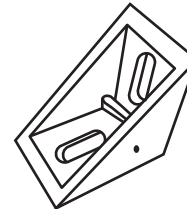

Corner Clips (12)

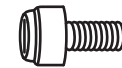

Nylon Screw (4)



Screws (24)



Nuts (24)

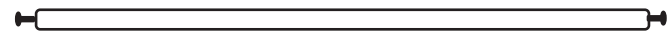

Perches (2) 23" (1) 22"

Step 1

To assemble the back piece:

Lay the back of the cage flat on a hard surface. Position the back piece so the bottom is closest to you. Remove the screws from the two 23" perches and mount the two perches to the back piece. Tighten the screws.

Using the hex nut driver and a Philips screw driver, install six clips onto the back piece. The edge of the clips should be in line with the side edge of the back piece (*Fig 1-1*).

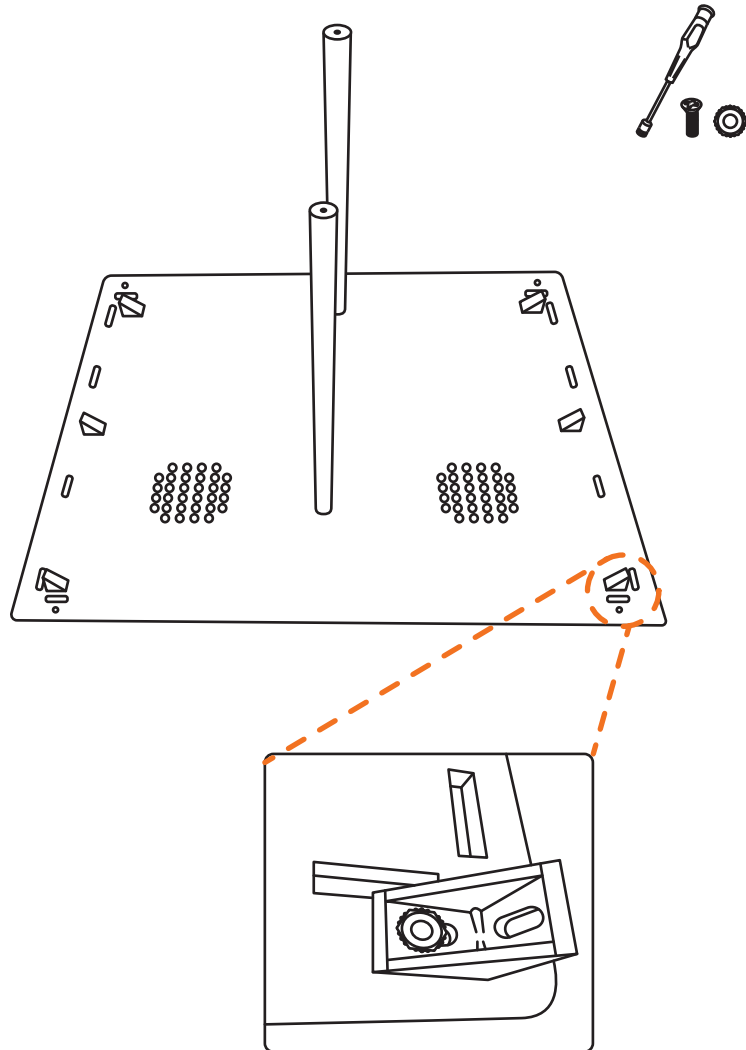

Fig. 1-1

Step 2

To assembly the top, bottom, and side pieces:

While not necessary, it may be helpful to have a second person assist in holding the pieces during this step.

Attach the top and bottom pieces by gently pressing the pegs into the plugs on the back piece.

Attach the right piece onto the back by gently pressing the pegs into the plugs (please note, the front of the side piece has only three peg while the back of the side piece has four pegs). Remove the screws from the 22" perch and mount the perch onto the right-side piece (please note, the perch can be mounted onto any side hole, this is personal preference). Attach the left-side piece and screw the perch in. Make sure that all the pegs are secured into their plugs.

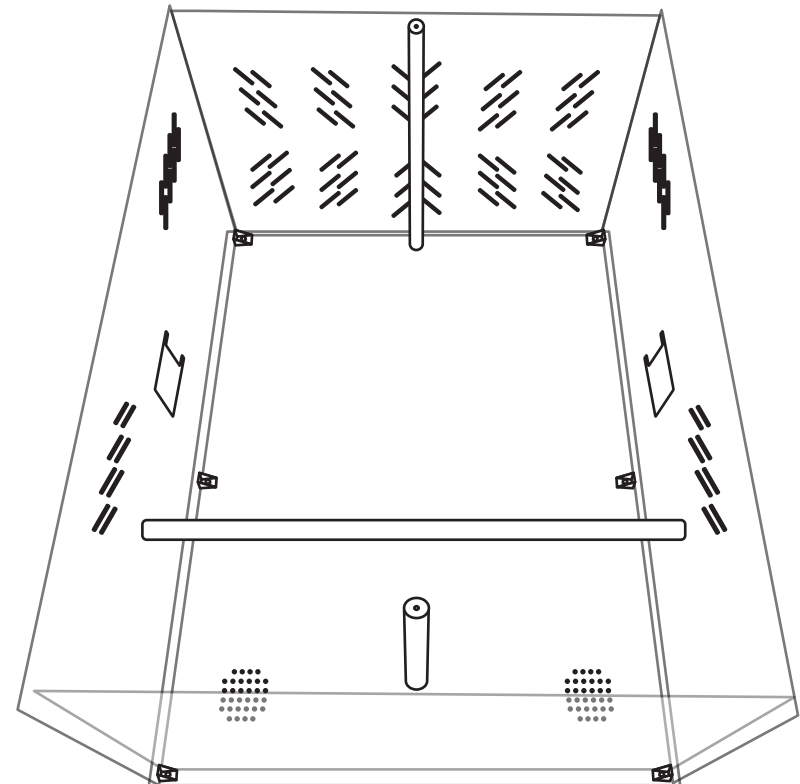

Step 3

Secure the cage:

Add the second set of screws and nuts to the bottom six corner clips. This will secure the sides of the cage to the back of the cage (**Fig 3-1**).

Using the hex nut driver and a Philips screw driver, install six clips onto the front edge of both side pieces. The edge of the clips should be in line with the long edge of the side pieces (**Fig 3-2**).

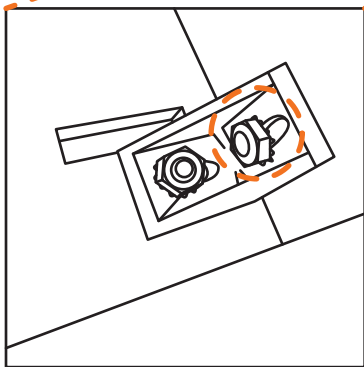
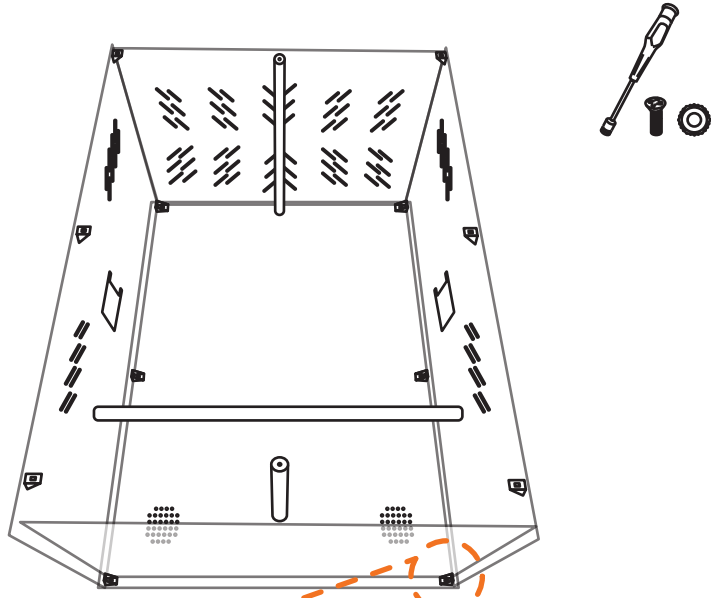

Fig 3-1

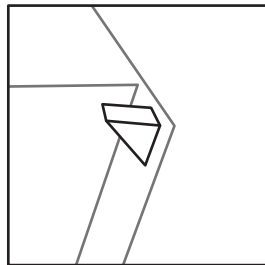

Fig 3-2

Step 4

To assemble the front piece:

Open the doors, place the front piece onto the cage and gently press the pegs into the plugs. Take two screws and secure the two perches extending from the back piece into place.

Install the door jams on the inside of the cage. The door jams go on the inside of the cage, but are screwed on from the outside (**Fig 4-1**).

Install a door knob onto each door. Tighten the screw from the back of the door (**Fig 4-2**).

Add the second set of screws and nuts to the front six corner clips. This will secure the sides of the cage to the front of the cage.

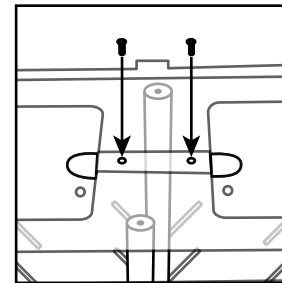
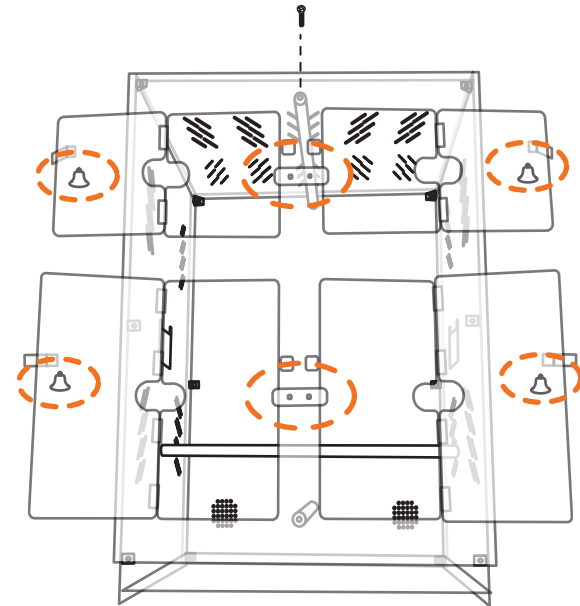

Fig 4-1

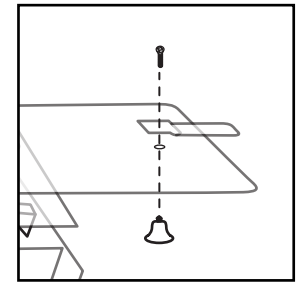

Fig 4-2

Step 5

Install the side face plate:

Screw in two nylon screws into the holes next to the large opening on the side of the cage (**Fig 5.1**). Do not screw the nylon screws fully in, only half way. Gently press the head of the screw through the large portion of the keyhole on the face plate, then let it slide down into the secured position. Once positioned, tighten the screws (**Fig 5.2**).

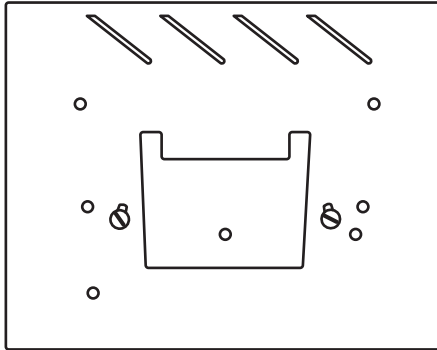

Fig 5.1

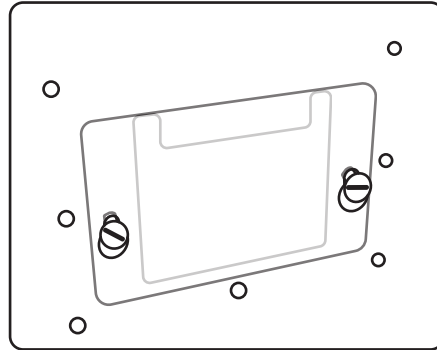

Fig 5.2

Step 6

Assembly the tray:

Attach the faceplate to the tray by aligning the holes and tightening the screws into the knobs. **The larger gap on the front plate goes towards the bottom.** Slide the tray into the open space at the bottom of the acrylic cage.

Flip the unit up right so the bottom piece is now flat on the hard surface.

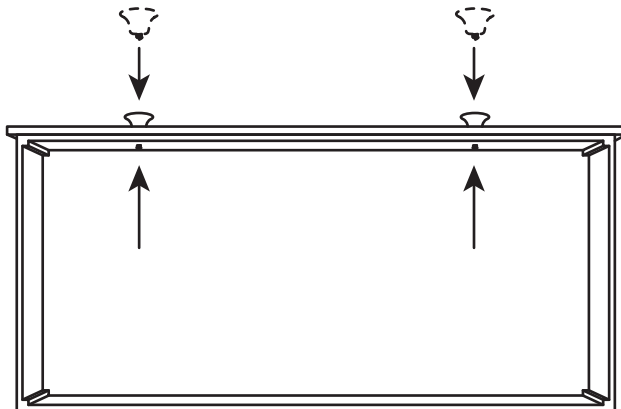

THE CAGE IS NOW FULLY ASSEMBLED AND READY FOR USE.

THE ACRYLIC DRILL BIT IS INCLUDED TO ASSIST IN INSTALLATION OF ANY EXTRA ACCESSORIES.

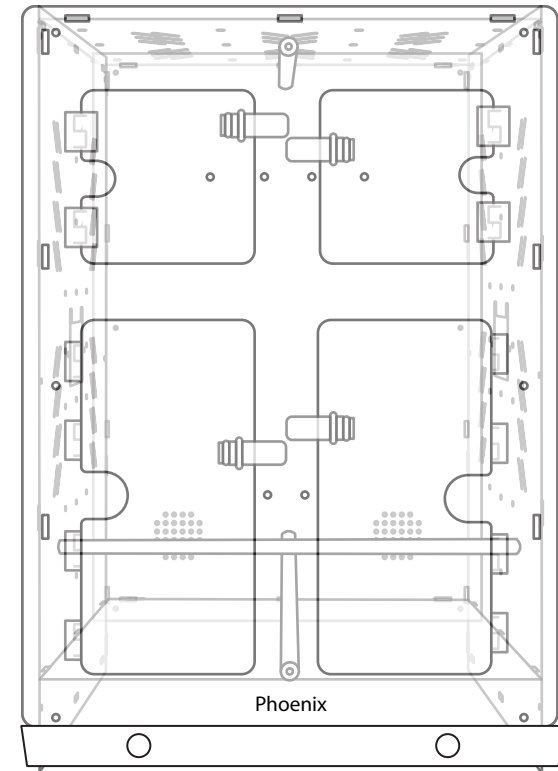

CLEANING & CARE INSTRUCTIONS!

1. When cleaning the cage, use an ammonia free glass cleaner or mild dish soap. We recommend SprayWay Cleaner.
2. After washing, dry the cage thoroughly with a soft cotton cloth to prevent scratches or residue. Do not leave the tray in the sun to dry.
3. Any minor hazing or fine scratches can be buffed out with a plastic polish. We recommend Novus Polish #2.
4. For worn or soiled perches, replace with untreated wood dowels.