

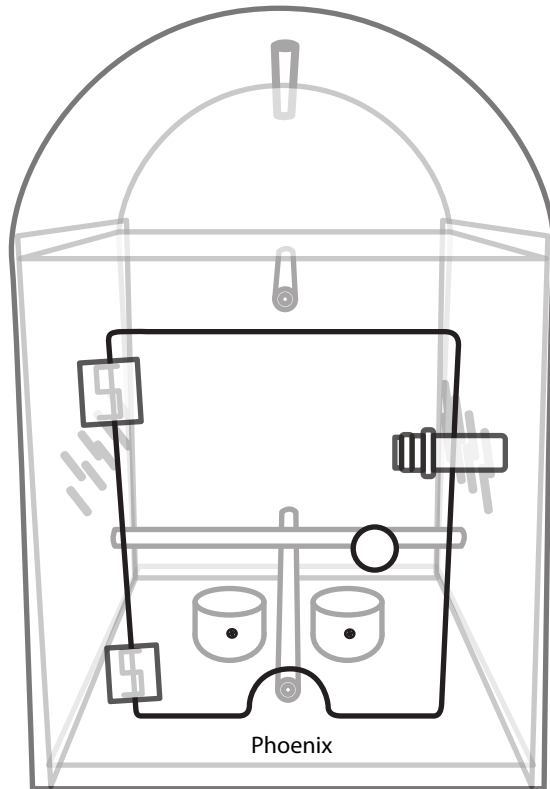

ACRYLICARRIER MEDIUM



ASSEMBLY INSTRUCTIONS

Getting started! Read these notes first:

1. Review these instructions thoroughly before attempting to assemble the carrier. If you still require assistance, please contact **Acrylic Habitats Customer Service**.
 - a. Phone: [\(984\) 777-4811](tel:9847774811)
 - b. Email: customerservice@acrylichabitats.com
 - c. Online: www.acrylichabitats.com
2. **Review All Parts:** If parts have been damaged or are missing, please contact Acrylic Habitats Customer Service.
3. **Tools:** Phillips Screw Driver (not included). If using power tools, please be careful not to overtighten any screws.
4. Two-person assembly is recommended for best results.
5. **Protective Paper:** Please note the orientation stickers on the protective paper. Test fit all pieces before removing the paper. If any of the protective paper sticks to the acrylic, we recommend using Goo Gone or an ammonia free glass cleaner to remove excess glue.
6. **Return Policy:** Returns are ONLY accepted in the original packaging with the protective paper still intact.
7. Visit www.acrylichabitats.com for tutorials and assembly videos!
8. Please do not leave the carrier outside in direct sunlight. Acrylic is an insulative material and may overheat.



Parts List

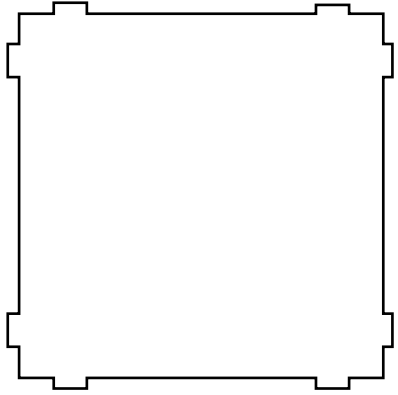

Bottom

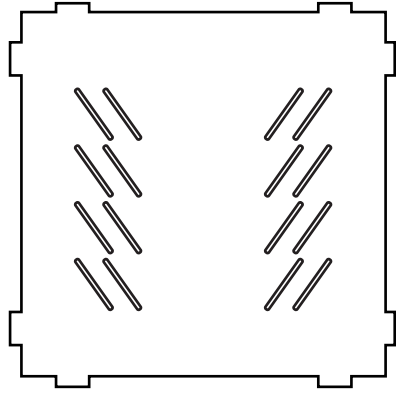

Top

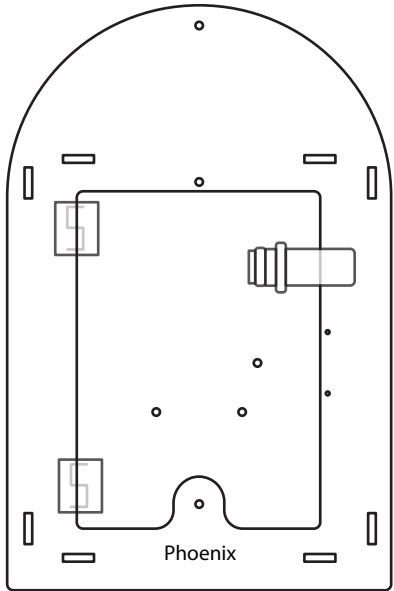

Front

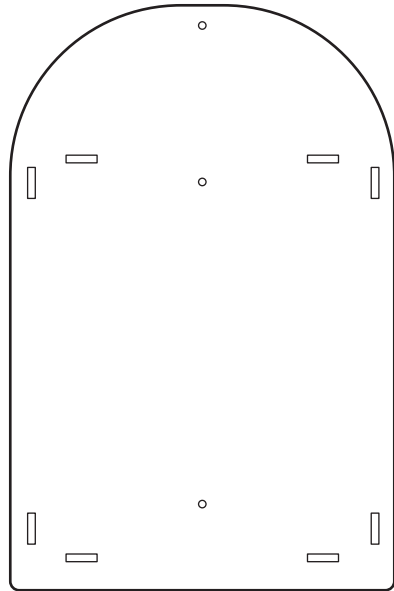

Back

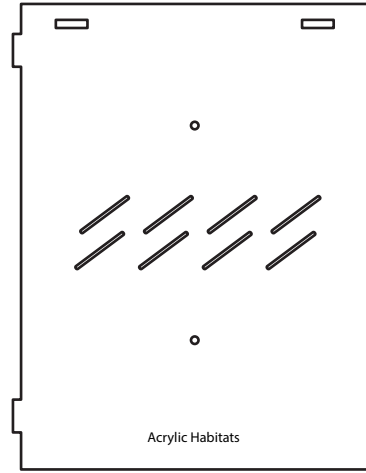

Left Side

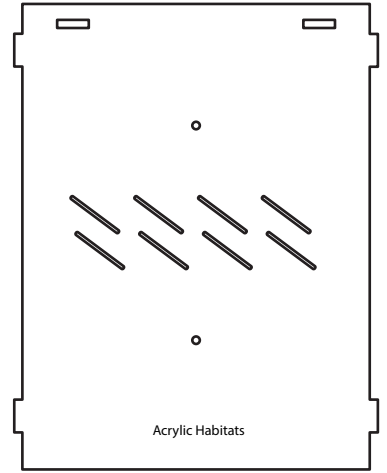

Right Side

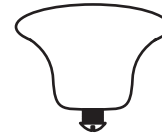

Door Knobs with screws (1)



Door Jam with screws (1)

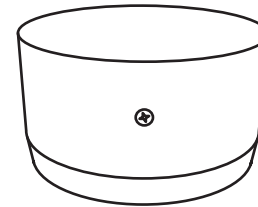

Stainless Steel Feeder Cups (2)

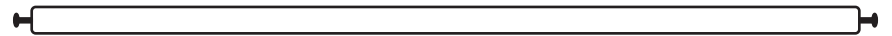

Perches (4) 10.5"

Step 1

To assemble the back piece:

Lay the back of the carrier flat on a hard surface. Position the back piece so the bottom is closest to you. Remove the screws from three 10" perches and mount the three perches to the back piece. Tighten the screws.

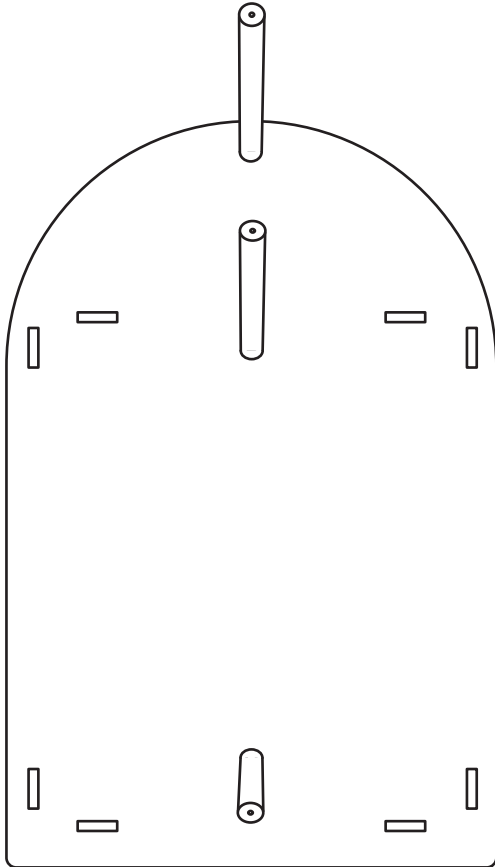

Step 2

To assemble the top, bottom, and side pieces:

Attach the top and bottom pieces by gently pressing the pegs into the plugs on the back piece.

Attach the right piece onto the back by gently pressing the pegs into the plugs (please note the orientation of the logo). Remove the screws from the last 10" perch and mount the perch onto the right-side piece. Attach the left-side piece and screw the perch into the left-side piece. Make sure that all the pegs are secured into their plugs.

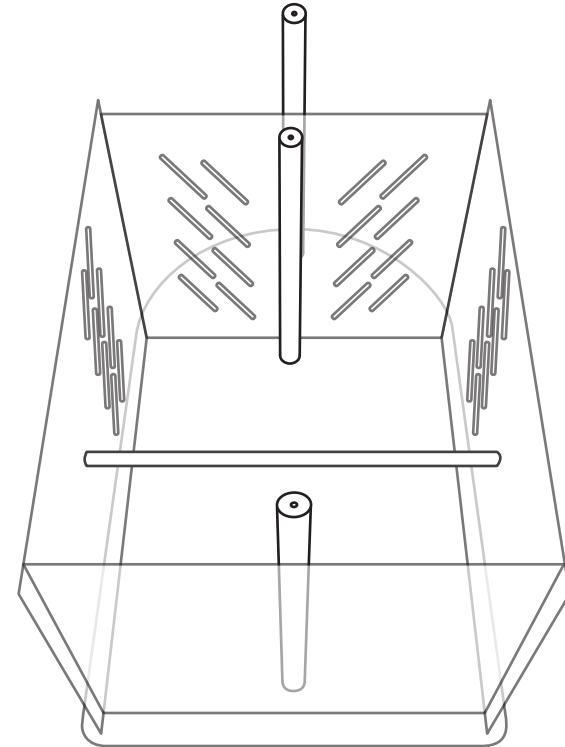

Step 3

To assemble the front piece:

Open the door, place the front piece onto the carrier and gently press the pegs into the plugs. Take three screws and secure the three perches extending from the back piece into place.

Install the door jam on the inside of the carrier. The door jam goes on the inside of the carrier, but it is screwed on from the outside (Fig 3-1)

Install the door knob. Tighten the screw from the back of the door (Fig 3-2).

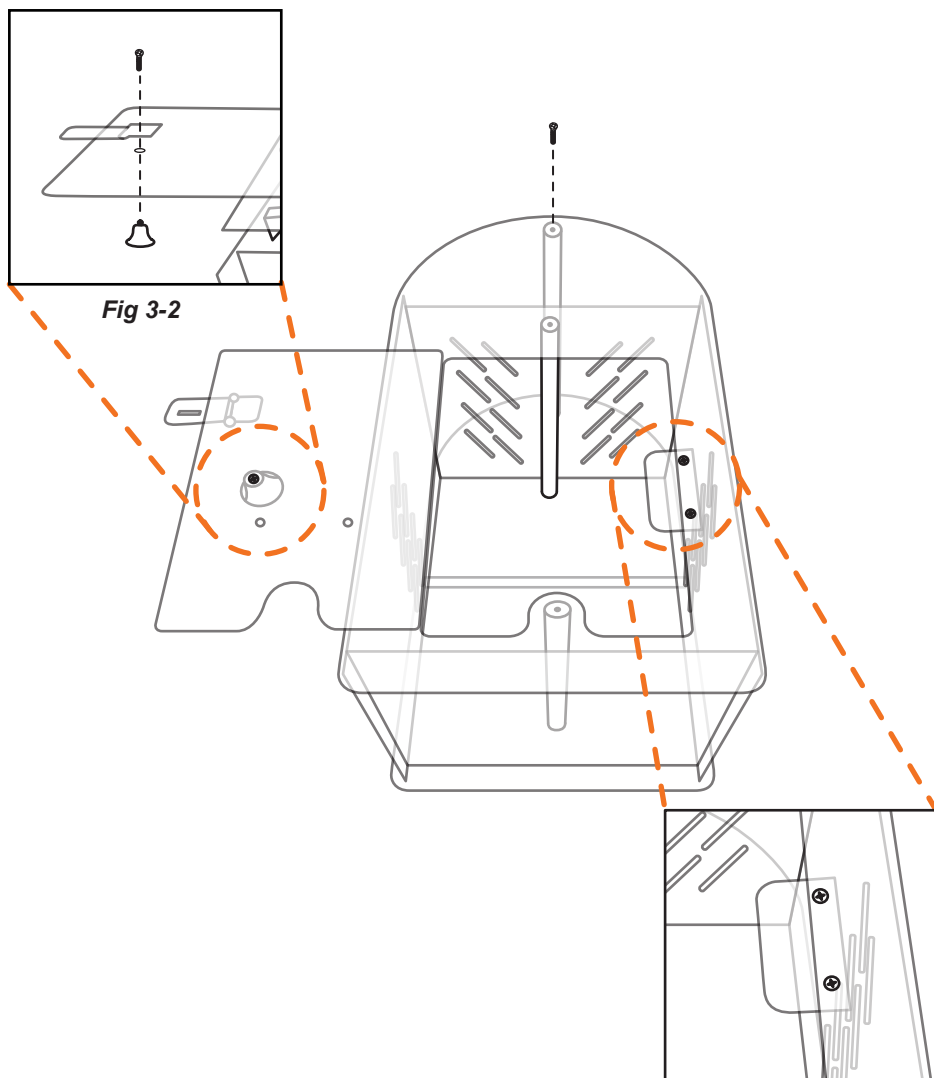

Fig 3-1

Step 4

To add the feeder cups:

Flip the unit up right so the bottom piece is now flat on the hard surface. Gently screw in the two feeder cups to the inside of the door.

THE CARRIER IS NOW FULLY ASSEMBLED AND READY FOR USE.

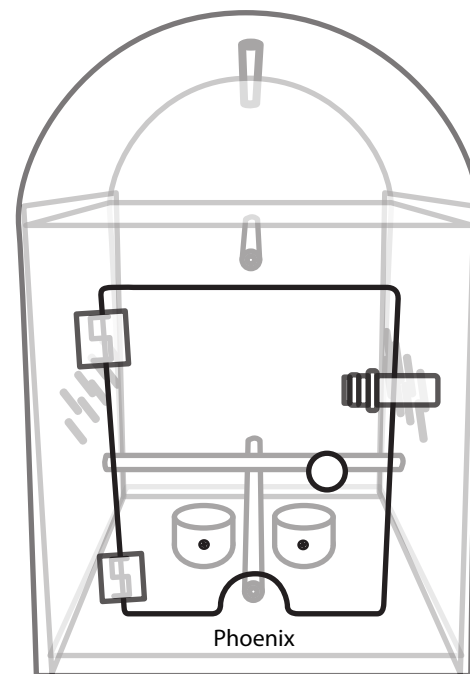

CLEANING & CARE INSTRUCTIONS

1. When cleaning the carrier, use an ammonia free glass cleaner or mild dish soap. We recommend SprayWay Cleaner.
2. After washing, dry the carrier thoroughly with a soft cotton cloth to prevent scratches or residue. Do not leave in the sun to dry.
3. Any minor hazing or fine scratches can be buffed out with a plastic polish. We recommend Novus Polish #2.
4. For worn or soiled perches, replace with untreated wood dowels.